

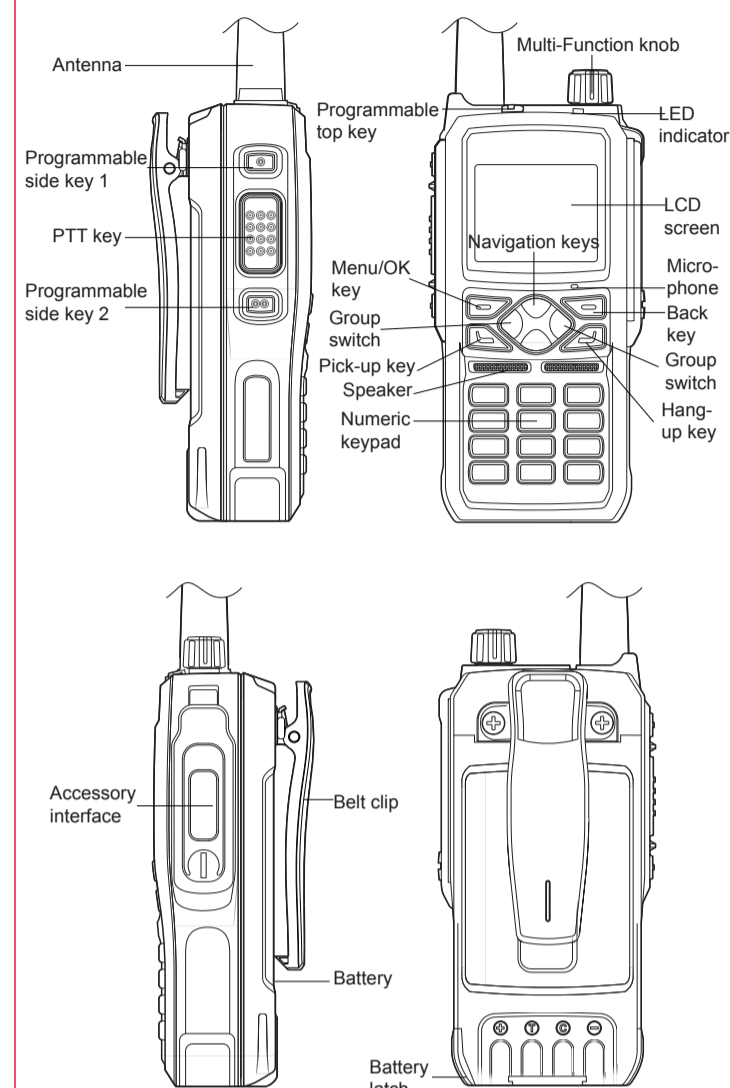

**PoC Trunked Two-way Radio
GP700
Quick Guide**

Please read carefully the Safety information before using the product.

Appearance



Charging the Battery

- Take the following steps to charge the battery.
1. Plug the power adapter into an AC power socket of the required specifications.
 2. Connect the power adapter to the charger, and green power indicator light will be on.
 3. Put a battery solely or attached to the device into the charger.
 4. Ensure the battery contacts well with the charging terminals. Red charging indicator light is on.
 5. After charging for about 6 hours, the charging indicator will turn green. The battery is fully charged.
 6. After the indicator light turns green, wait 1 to 2 hours before taking out the battery, so as to achieve the best battery performance.
 7. Disconnect the power adapter from the socket.

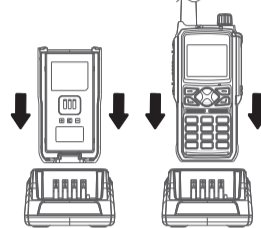

Installing the Battery

1. Press the upper part of the belt clip gently so that it goes up. (Figure 1)
2. Align the battery with the battery holder at the back of the device, and insert the battery. (Figure 2)
3. Push the battery in the direction indicated until the latch is in position. (Figure 3)
4. Press the lower part of the battery until it is latched. (Figure 4)

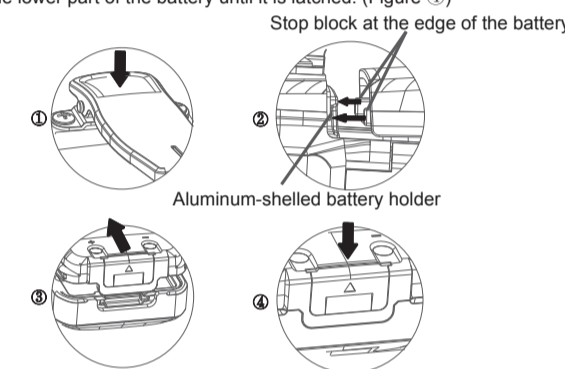

Installing/Uninstalling the Antenna

To install the antenna, plug the threaded end into the antenna interface, and rotate the antenna clockwise until it is tight.
To uninstall the antenna, rotate it counterclockwise.

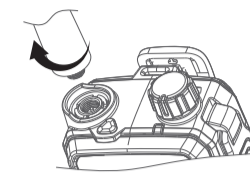

Installing/Uninstalling Belt Clip

To install the belt clip, align the two screw holes on the belt clip with the two at the back of the device, and fasten the screws.
To uninstall the belt clip, loosen the screws, and then take off the belt clip.

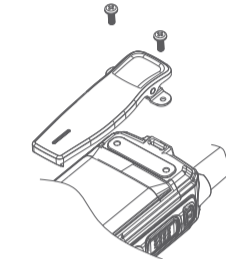

Installing an Accessory

To use an audio accessory or the programming cable, screw down the screw on the earphone cover, take down the accessory cover, plug the accessory or cable into the interface, and screw up the screw.

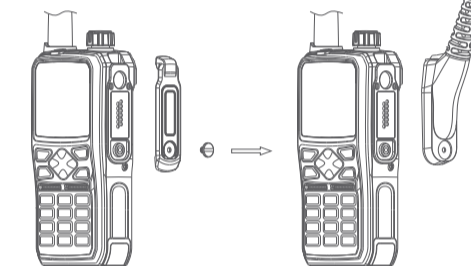

Installing the SIM Card

- Note: Please use a standard Nano-SIM card.
1. Unscrew the screw on the card cover using the supplied screwdriver, open the cover, and take out the instructions card.
 2. Insert a SIM card into the slot of the card holder (Figure 1), and close the card holder cover. (Figure 2)
 3. Lock the card holder cover by sliding it in the indicated direction. (Figure 3)
 4. Close the card cover and screw up the screw (Figure 4)

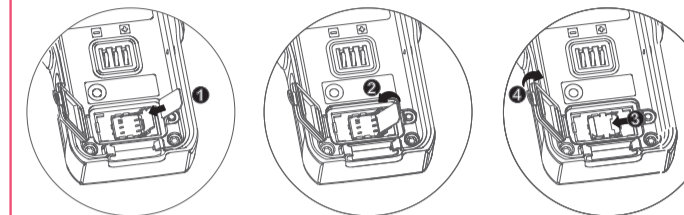

LED Indicator

Indicator state	Device State
Red light on	A. No SIM card is installed, or it is installed improperly. There is a voice prompt "No SIM card". B. Fail to unlock the PIN code of the SIM card.
Green light on	During a call (i.e. individual/group/all call).
Orange light on	A. The device is in individual-call standby state. B. The device is in call setup state. C. The device is unregistered or expired, so that it is not deployed on the server.
Red light flashing fast	Network registration fails because the SIM card is inactivated or a bill is unpaid. Device registration fails because of poor wireless network connection.
Green light flashing slow	The device is registered to a network successfully and enters standby state.
Idle	The device is idle or powered off.



Kirisun Communication Co., Ltd.

Version: V1.0



167W0600213

Icons

Icon	Description
	Received signal strength indication
	2G/3G/4G network
	Wi-Fi received signal strength indication
	Searching GPS satellite signals
	GPS signals acquired and locked up
	In group call
	In individual call
	In all call
	Short message
	Remaining battery capacity
	Bluetooth on
	Bluetooth device paired
	In emergency alarm
	Alarm message

Basic Operation

1.Powering On/Off

To power on/off the device, hold down the Multi-Function knob and release after 2 seconds.
The screen and green LED indicator light will be on, and the message "initializing" will be displayed.
Note: If no SIM card is installed or the card is unregistered or invalid, you will hear the voice prompt "No SIM card".

2.Adjusting the Volume

After power-on, rotate the Multi-Function knob clockwise to increase the volume or counterclockwise to decrease it.

3.Switching Groups

Method 1: After power-on, press the Multi-Function knob and rotate it within 3 seconds to switch to another group. If no operation is performed within this time, the knob will enter volume adjustment mode.
Method 2: In standby state, press the left/right navigation keys to switch to another group.

Basic Operation

4.Initiating a Call

Hold down the PTT key to initiate a call on the selected channel.

5.Receiving a Call

When a call is received, green indicator light will be on.

6.Network Type

To choose a network type, in the standby interface, press the Menu/OK key to enter the menu, select Setting – Network Type.

7.Low-Power Alert

When the battery level is below 10%, you will hear the voice alert "Low power. Please charge the battery." periodically. Please replace or charge the battery after powering off the device.

8.Voice Playback

To play back the latest 99 voice records, enter the voice records; to play back the latest 5 records, press the programmed playback key.

9.Positioning

To enable/disable positioning, in the standby interface press the Menu/OK key to enter the menu, and select Setting – GPS. The built-in GPS module locates the device and reports position information to the network management system. The real-time location and movement track of the device can be displayed on a GIS map on the network management system or dispatcher software.

10.WiFi

To enable/disable WiFi, in the standby interface press the Menu/OK key to enter the menu, and select Setting – WiFi. After enabling WiFi, you can search and connect to a nearby WiFi network in real time and set a password.

11.Bluetooth

To enable/disable Bluetooth, in the standby interface press the Menu/OK key, and select Setting – Bluetooth. After enabling Bluetooth, you can scan for and pair with a BT earphone that is in pairing mode.

12.Short Message

To send the message, in the standby interface press the Menu/OK key, select Message – Short Message, write a message, select a contact, and send the message.
To view the short messages received/sent, press the Menu/OK key, and select Inbox/Outbox.

13.Advanced Functions

Via dispatcher software, you can revive, stun or kill the device, play back voice, or perform background monitoring on another device.

14.All Call

In the standby interface, dial "100000" and press the Menu/OK key to enter all-call mode. Hold down the PTT key to initiate an all call. A callee must reply within 3 seconds after receiving the call, otherwise the radio will quit all-call mode.
An all call overrides an ongoing group call or individual call.

15.Broadcast Call

In the standby interface, dial "100001" and press the Menu/OK key to enter broadcast-call mode. Hold down the PTT key to initiate a broadcast call. A callee can receive but not reply to the call. A broadcast call overrides an ongoing group call or individual call.

16.Emergency Alarm

Two emergency alarm types are supported.

- (1) Manual alarm: Hold down the programmable top key for seconds to enter/quit alarm mode.
- (2) Man Down alarm: The radio enters alarm mode when it is laid down. (Require permission granted via the NMS.)

Each emergency alarm type has two modes. Please set at "Menu" "Settings" "Alarm Modes"

- (1) Silent Alarm Sending: The radio sends an emergency alarm silently. After disabling this mode, the radio sends an alarm with a siren.
- (2) Silent Alarm Receiving: The radio receives an emergency alarm silently. After disabling this mode, the radio receives an alarm with a siren and a voice prompt "SOS alarm from ***".

You can view sent alarms and received alarms at "Menu" "Message Records" "SOS Messages".

17. Others

[*] key: Press it to turn off the screen and enter Power Saver mode; hold it down for seconds to lock/unlock the keypad.
Programmable side key 1: By default, press it to announce the selected channel; hold it down for seconds to announce remaining battery capacity.
Programmable side key 2: By default, press it to announce the user name; hold it down for seconds to enter individual-call mode.

Troubleshooting

No.	Problem	Solution
1	Power-on failed	1. The battery is out. Charge or replace the battery. 2. and solution: The Multi-Function knob is faulty, or there is another problem. Get the device repaired at an authorized service station.
2	Low voice during a call	1. Speak too far from the microphone. Please keep a distance of 3 ~ 10cm. 2. and solution: Inappropriate volume setting. Increase the volume by rotating the Multi-Function knob clockwise.
3	PTT service unavailable	1. The SIM card is expired. Refill or replace it. 2. Incorrect group setting. Choose a correct group and try again. 3. The device is expired. Renew it.

Attachments

No.	Name
1	Main unit
2	Battery
3	Antenna
4	Power adapter
5	User manual
6	Safety Information
7	Strap
8	Desktop charger

Caution

Maximum ambient temperature: maximum battery temperature 45°C, recommended product temperature 40°C or below.

This document is only for reference, and actual product prevails. Kirisun reserves the right to the final interpretation of this document.